

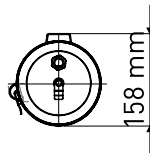

Sammode  
Studio

# Rimbaud

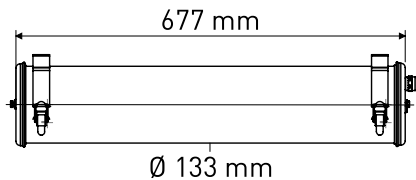
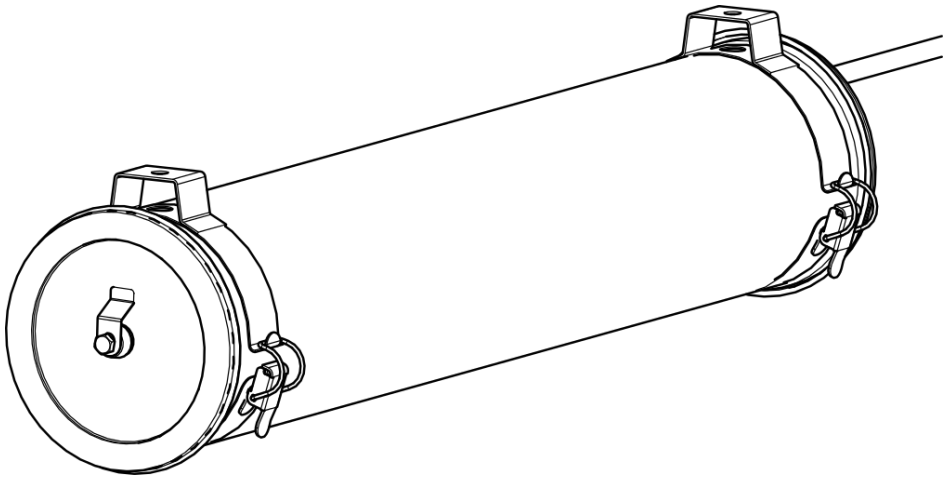

# Montage

Mounting / Montage

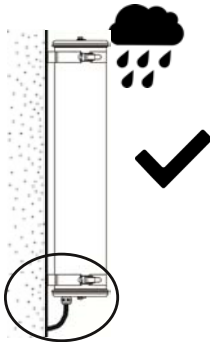
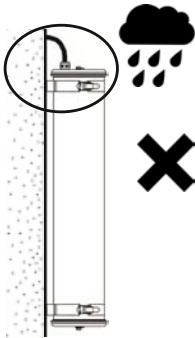
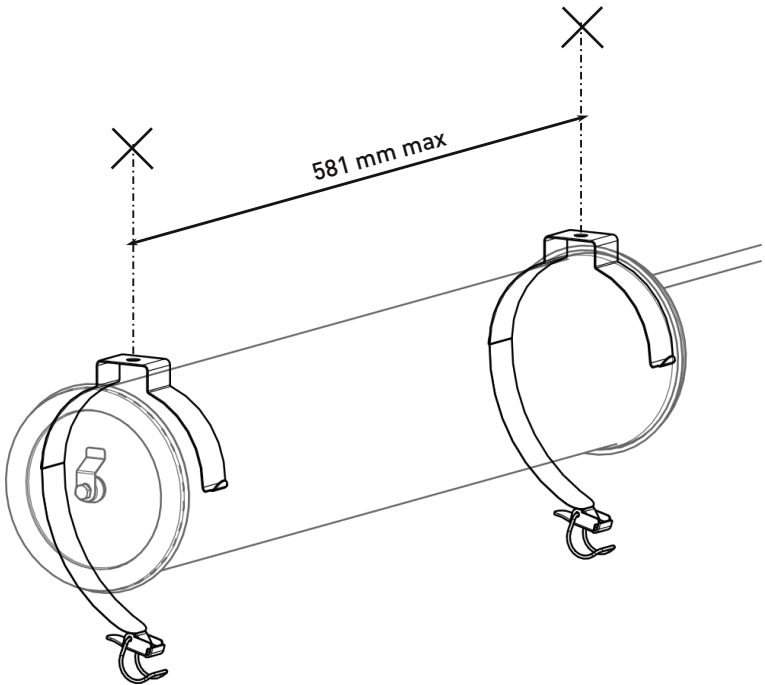

# Changement de lampe

Change the lamp / Lampenwechsel



Les lampes fournies par Sammode permettent un fonctionnement optimal du produit.  
En cas de remplacement, nous recommandons l'utilisation de modèles strictement équivalents.

Lamps are provided by Sammode for an optimal functioning.  
In case of relamping, we highly recommend the use of similar lamps.

Der besten Betrieb der Leuchten wird mit von Sammode gelieferten Leuchtmittel geprüft.  
Beim Austausch der Leuchtmitteln empfehlen wir ähnliche Leuchtmittel zu verwenden.



**Ne pas ouvrir sous tension**  
**Do not open when energized**  
**Nicht unter Spannung öffnen**

1.

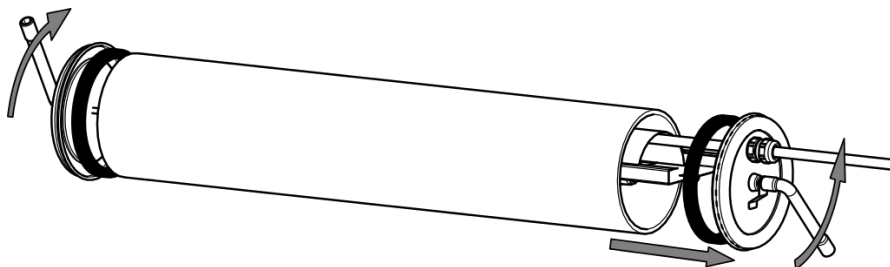

2.

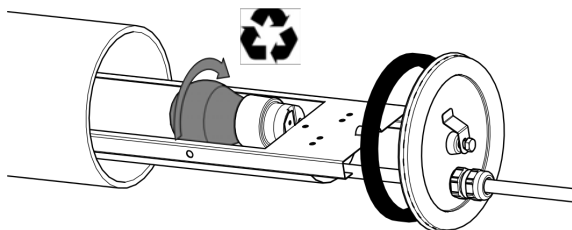

3.

